



Key Feature

- Two-pin wire for power supply and network access
- Access control function
- Noise suppression and echo cancellation
- H.264 video compression
- Low illumination
- Tampering alarm
- Fisheye camera with IR supplement light
- Supports sub-modules' access (max. 8)
- Nametag customization
- Easy to and extend

	d. EN 50130-4:2011 +A1:2014
CE-LVD	EN 60950-1:2006 + A11:2009 + A1:2010 + A12:2011 + A2:2013
CB	IEC 60950-1:2005 (Second Edition) + Am 1:2009 + Am 2:2013
FCC-SDOC	47 CFR Part 15, Subpart B
C-TICK(EMC)	AS/NZS CISPR 32:2015
UL	UL 60950-1 & CAN/CSA C22.2 No. 60950-1-07, Information Technology Equipment – Safety – Part 1: General Requirements
ROHS	2011/65/EU
REACH	Regulation (EC) No 1907/2006
WEEE	2012/19/EU

Typical Application

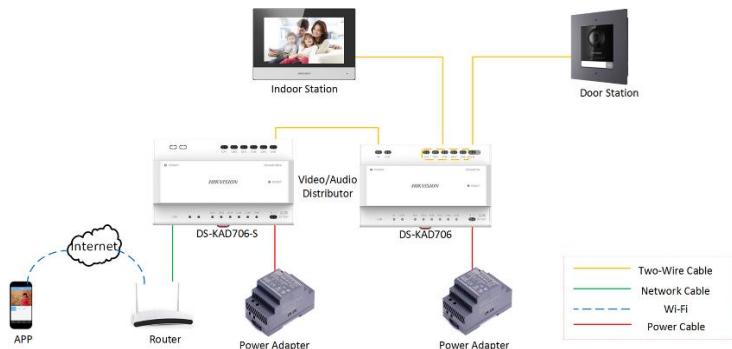

Approval

CE-EMC	a. EN 55032:2015
	b. EN 61000-3-2:2014
	c. EN 61000-3-3:2013

Specification

System parameters	
Processor	Embedded MCU Processor
Operation system	Embedded Linux operation system
Operation method	Physical button
Video Parameters	
Camera	Low illumination 2 MP HD IR camera
Video Compression Standard	H.264
Resolution	Main stream : 1920 × 1080 Sub stream : 720 × 480
Video stream	Main stream: 1080p@30fps, 720p@30fps (configurable); sub stream: D1
BLC	Supported
DNR	Supported
WDR	Supported
Anti-flicker	50 Hz, 60 Hz
Field of view	Horizontal: 180° Vertical: 96°
Motion detection	Supported
Audio parameters	
Audio intercom	Full-duplex two-way audio intercom
Audio input	Built-in omnidirectional microphone
Audio output	Built-in loudspeaker (More than 85 dB within 20 cm)
Audio compression standard	G.711 U
Audio compression Rate	64 Kbps
Audio quality	Noise suppression and echo cancellation
Light supplement	
Light supplement mode	IR supplement
Network parameters	
Wired network interface	Two-wire transmission
Network protocol	TCP/IP, RSTP
Access control	
Relay interface (main module)	2, NO + NC separately draw forth
Interfaces	
Module-connecting	1
Tampering alarm	1
Alarm input	4
Performances	
Card capacity	Max. 10000
User capacity	Max. 2000
Linked Indoor station	Max. 100

Linked sub door station	Max. 8
Linked doorphone	Max. 8
Protocol	ISAPI, RTSP, STMP, SNMP
Unlock door	Unlock by presenting cards, unlock via Client Software, unlock via App, unlock via indoor station

General	
Physical button	1
Protection level	IP 65
Power input	24 VDC two-wire power supply (< 16 W) or 12 VDC independent power supply (< 20 W)
Power output	12 VDC (only for power supply of submodule)
Working temperature	-40° C to +60° C (-40° F to 140° F)
Working humidity	10% to 95%
Installation	Flush mounting, surface mounting
Dimension	98 mm × 99.8 mm × 43.9 mm (3.86" × 3.93" × 1.73")
Material	Stainless steel

Available Model

DS-KD8003-IME2/S

Appearance and Interfaces

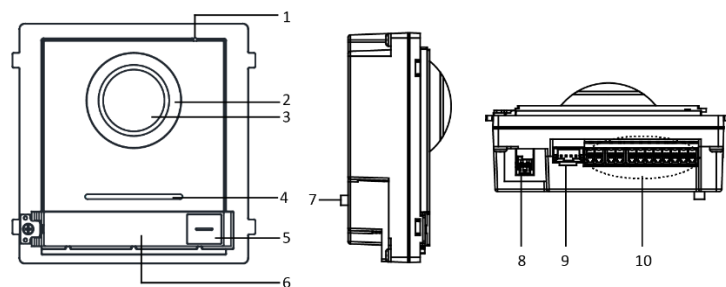

No.	Description	No.	Description
1	Microphone	6	Nametag
2	Low Illumination IR Supplement Light	7	TAMPER
3	Built-in Camera	8	Network Interface and Power Supply
4	Loudspeaker	9	Module-connecting Interface (output)
5	Call Button	10	Terminals

Dimension

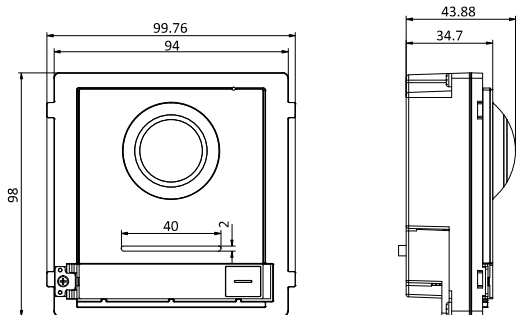

DS-KD-ACF3/S



DS-KD-ACW1/S

Accessory

Optional



DS-KD-ACF1/Plastic

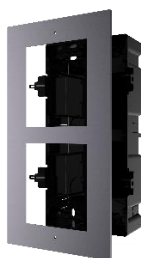

DS-KD-ACF2/Plastic

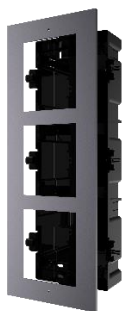

DS-KD-ACF3/Plastic

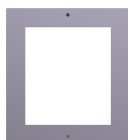

DS-KD-ACW1



DS-KD-ACW2



DS-KD-ACW3



DS-KD-ACF1/S

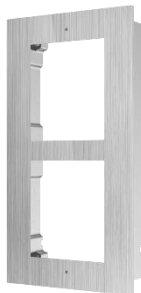

DS-KD-ACF2/S



DS-KD-ACW2/S

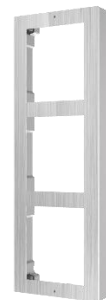

DS-KD-ACW3/S

Distributed by

**HIKVISION®****Headquarters**

No.555 Qianmo Road, Binjiang District,
Hangzhou 310051, China
T +86-571-8807-5998
overseasbusiness@hikvision.com

Hikvision USA
T +1-909-895-0400
sales.usa@hikvision.com

Hikvision Australia
T +61-2-8599-4233
salesau@hikvision.com

Hikvision India
T +91-22-28469900
sales@pramahikvision.com

Hikvision Canada
T +1-866-200-6690
sales.canada@hikvision.com

Hikvision Thailand
T +662-275-9949
sales.thailand@hikvision.com

Hikvision Europe
T +31-23-5542770
sales.eu@hikvision.com

Hikvision Italy
T +39-0438-6902
info.it@hikvision.com

Hikvision Brazil
T +55 11 3318-0050
Latam.support@hikvision.com

Hikvision Turkey
T +90 (216)521 7070- 7074
sales.tr@hikvision.com

Hikvision Malaysia
T +601-7652-2413
sales.my@hikvision.com

Hikvision UK & Ireland
T +01628-902140
sales.uk@hikvision.com

Hikvision South Africa
Tel: +27 (10) 0351172
sale.africa@hikvision.com

Hikvision France
T +33(0)1-85-330-450
info.fr@hikvision.com

Hikvision Kazakhstan
T +7-727-9730667
nikia.panfilov@hikvision.ru

Hikvision Vietnam
T +84-974270888
sales.vt@hikvision.com

Hikvision UAE
T +971-4-4432090
salesme@hikvision.com

Hikvision Singapore
T +65-6684-4718
sg@hikvision.com

Hikvision Spain
T +34-91-737-16-55
info.es@hikvision.com

Hikvision Tashkent
T +99-87-1238-9438
uzb@hikvision.ru

Hikvision Hong Kong
T +852-2151-1761
info.hk@hikvision.com

Hikvision Russia
T +7-495-669-67-99
saleru@hikvision.com

Hikvision Korea
T +82-(0)31-731-8817
sales.korea@hikvision.com

Hikvision Poland
T +48-22-460-01-50
info.pl@hikvision.com

Hikvision Indonesia
T +62-21-2933759
Sales.Indonesia@hikvision.com

Hikvision Colombia
sales.colombia@hikvision.com