

## DS-2CE72KF3T-LE 3K ColorVu PoC Fixed Turret Camera



- High quality imaging with 3K, 2960 × 1665 resolution
- Excellent low-light performance
- 24/7 color imaging with F1.0 aperture
- Clear imaging against strong back light due to 130 dB true WDR technology
- 3D DNR technology delivers clean and sharp images
- 2.8 mm and 3.6 mm fixed focal lens
- Up to 40 m IR distance for bright night imaging
- Up to 40 m white light distance for bright night imaging
- Water and dust resistant (IP67)
- Smart-Hybrid light, optimize your security with flexible lighting options

## ▪ Specification

Camera	
Image Sensor	3K CMOS
Signal System	PAL/NTSC
Max. Resolution	2960 (H) × 1665 (V)
Min. Illumination	0.0005 Lux @ (F1.0, AGC ON), 0 Lux with white light
Shutter Time	PAL: 1/25 s to 1/50,000 s; NTSC: 1/30 s to 1/50,000 s
Angle Adjustment	Pan: 0° to 360°, Tilt: 0° to 75°, Rotate: 0° to 360°
Lens	
Lens Type	2.8 mm and 3.6 mm fixed focal lens
Focal Length & FOV	2.8 mm, horizontal FOV: 110°, vertical FOV: 59°, diagonal FOV: 139° 3.6 mm, horizontal FOV: 90°, vertical FOV: 49°, diagonal FOV: 105°
Lens Mount	M12
Illuminator	
Supplement Light Range	IR: Up to 40 m, White Light: Up to 40 m
Smart Supplement Light	Yes
Image	
Frame Rate	3K @20 fps, 4 MP @25 fps/30 fps, 1080p @25 fps/30 fps
Privacy Mask	4 programmable privacy masks/8programmable privacy masks
Wide Dynamic Range (WDR)	≥130 dB
Image Parameters Switch	STD/HIGH-SAT/HIGHLIGHT
AGC	Yes
Day/Night Mode	Auto/Color/BW (Black and White)
White Balance	Auto/Outdoor/Global/Manual
Image Enhancement	WDR,BLC,HLC,Global,HLS
Noise Reduction	3D DNR/2D DNR
Image Settings	Brightness,Contrast,Mirror,Smart Light,Anti-Banding
Interface	
Video Output	1 HD analog output
Event	
Motion Detection	4 programmable motion areas
General	
Power	12 VDC±25%, PoC.at, Max.7.8 W,*You are recommended to use one power adapter to supply the power for one camera.
Language	English
Operating Condition	-40 °C to 60 °C (-40 °F to 140 °F). Humidity: 90% or less (non-condensing)
Material	Main body: Metal, Enclosure: Plastic
Communication	HIKVISION-C
Dimension	Ø109.98 mm × 98.27 mm (Ø4.33" × 3.87")
Weight	Approx. 360 g (0.79 lb.)
Approval	
Protection	IP67

## ▪ Available Model

DS-2CE72KF3T-LE(2.8mm)





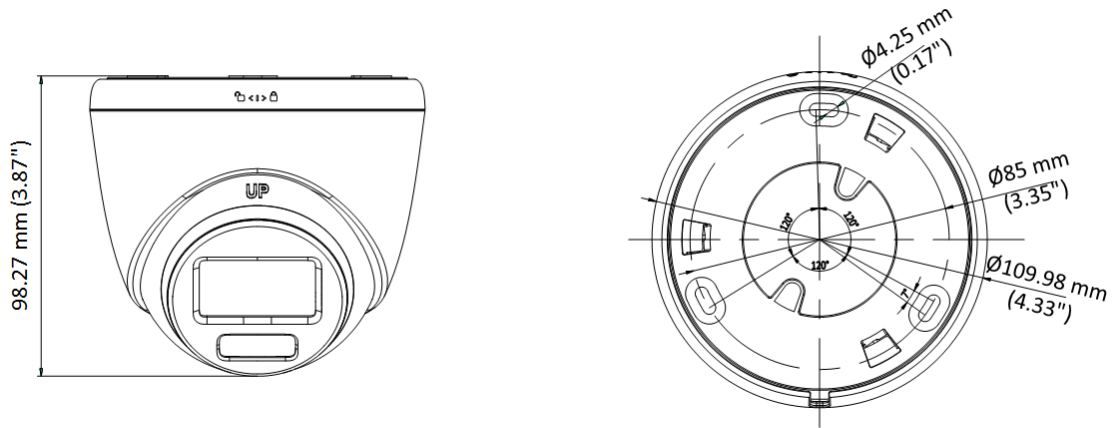



DS-2CE72KF3T-LE(3.6mm)

▪ **Dimension**

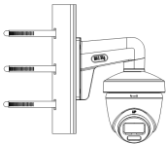
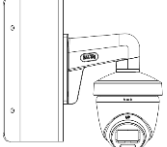
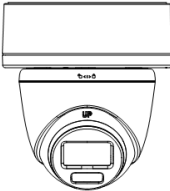
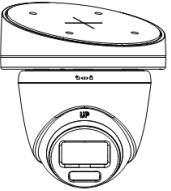

▪ **Accessory**

▪ **Optional**

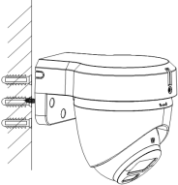
<b>DS-1272ZJ-110-TRS</b> Wall mount	<b>DS-1275ZJ-SUS</b> Vertical pole mount	<b>DS-1276ZJ-SUS</b> Corner mount	<b>DS-1280ZJ-S</b> Junction box	<b>DS-1281ZJ-S</b> Inclined ceiling mount
				
				
<b>DS-2280ZJ</b> Wall mount				
				
				

**Headquarters**

No.555 Qianmo Road, Binjiang District,  
Hangzhou 310051, China  
T +86-571-8807-5998  
www.hikvision.com



Follow us on social media to get the latest product and solution information.

