

Sinteso™ Cerberus™ PRO

## ASD Aspirating smoke detector

FDA241, FDA221



### Siemens aspirating smoke detector (ASD) for the addressed FDnet/C-NET detector line or for standalone operation

- Patented technology
- Early detection of a wider spectrum of particle sizes in the air
- Configuration using the USB interface or the control panel via FDCC221S (optional)
- 'ASD Asyst-Tool' software to assist with pipe configuration
- Unique dust-resistant detection chamber
- Intuitive front indicator for airflow and smoke value
- Access to service functions
- Different event protocols
- Offline/online configuration supported
- Cleaning function (FDA241)
- 4...20 mA output

## Properties

- Extended optical detection thanks to dual wavelengths (blue and infrared): The aspirating smoke detectors FDA241 and FDA221 use dual-wavelength technology to trigger an alarm at the earliest possible moment. They are designed to protect small and medium-sized business-critical environments for monitoring areas of up to 800 m<sup>2</sup> (FDA241) or 500 m<sup>2</sup> (FDA221). The detectors continually suck in air through a pipe system via their aspirating holes. The air is fed into a uniquely designed detection chamber, in which tiny smoke particles are detected by scattered light.
- Lower mounting and service costs: The aspirating smoke detectors FDA241 and FDA221 can be used on an FDnet/C-NET detector line. For this purpose, communication transponder FDCC221S is required.
- Configuration using the USB interface or the control panel via FDCC221S (optional): All detector configurations, maintenance work, and alarm and fault management processes can be carried out at a central location – the fire control panel. This ensures better control while also reducing the costs of the overall solution.
- 'Out-of-the-box' mounting and commissioning: Installation is simple thanks to combined functions for normalizing smoke values and airflow, as well as appropriate presettings for alarm and fault thresholds.
- ASD filter box FDAZ292 available as an accessory: Dust and other dirt is filtered out of the aspirated air and does not get into the aspirating smoke detector. The filters in the ASD filter box are easy to replace.

## Use

Aspirating smoke detectors are used for early detection of smoke-generating fires in rooms and equipment. They are especially suited to applications in which point detectors are pushed to their limits, cannot be used or can only be used with restrictions.

The aspirating smoke detector continually takes air from the monitored room using a connected pipe system with defined aspirating holes. The air is supplied to the detection chamber and is analyzed for smoke particles using the detector installed there. The sensitivity of the detector can be adjusted.

The position and size of the aspirating holes is calculated using the 'FXS2056 ASD Asyst Tool V2' software. The calculation ensures that the air passes from the aspirating hole to the detector in the time specified and with the required calculated sensitivity.



---

The 'FXS2056 ASD Asyst Tool V2' software replaces the 'FXS2055 ASD Asyst Tool' software.

---

### Examples of application

- Cavities such as false ceilings or false floors
- Clean rooms
- Rooms the height of which is greater than that permitted for point detectors
- Rooms with electromagnetic fields which influence the function of point detectors
- Large rooms up to 800 m<sup>2</sup>
- Separate monitoring of control cabinets and electronics cabinets
- Data centers
- Telecommunication centers
- Mounting lines
- Cable tunnels
- Conveyor belts

### Applications with a filter box

- Rooms with polluted air, in which the pollution has impaired the performance of optical point detectors
- Mounting lines
- Recycling facilities
- Cement factories

- Mining industry
- Subway stations
- Agricultural operations
- All other applications with visible dust load

## Functions

### Indication

The display contains clear, comprehensible bar graphs for smoke and airflow, as well as an alarm indicator, an error indicator, and a dust indicator (FDA241).

When the housing cover is open, the operator has access to the 'Reset', 'Normalize Smoke', and 'Normalize Flow' functions, as well as the mini USB connector.

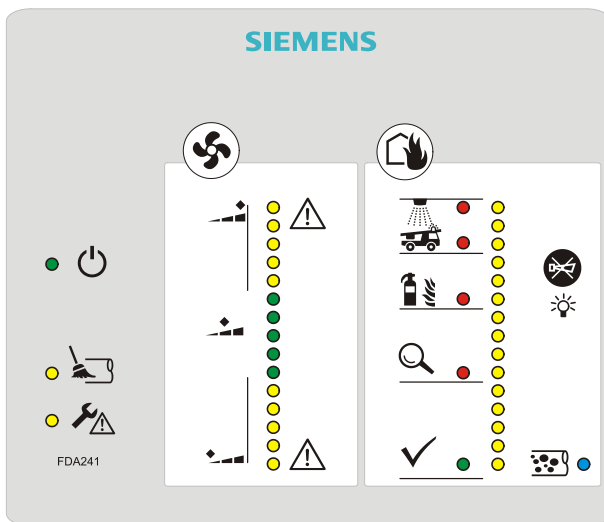

Fig. 1: Front indicator FDA241

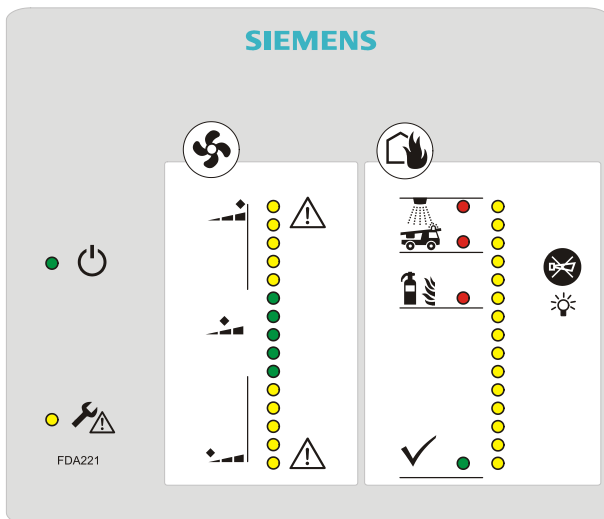
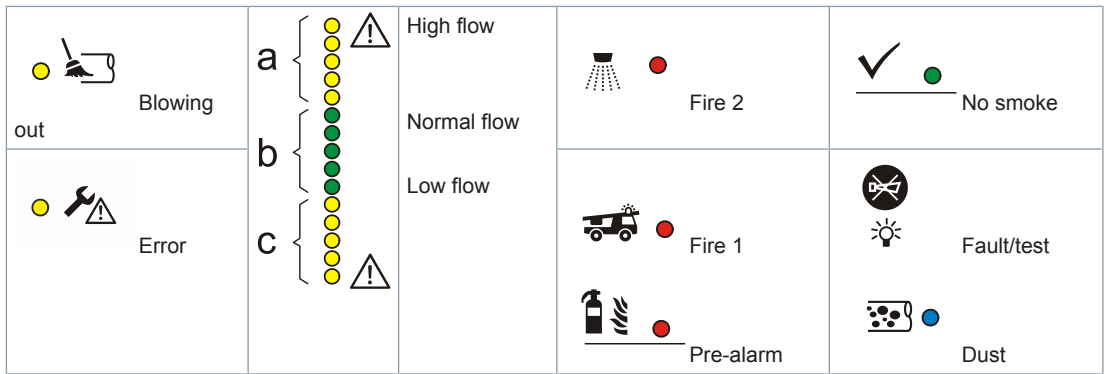



Fig. 2: Front indicator FDA221

### Legend for the response indicators

 			
Operation	Flow warnings	Smoke alarm	Info alarm



### Opening the detector

	 <b>CAUTION</b>
	<b>Damage to the connection cable</b> In order to prevent damage to the connection cable when positioning the housing cover, make sure that the connection cable has been routed correctly.

The service area for the detector can be accessed in two ways.

- Partial access:
  - Remove the two screws on the top of the detector.
  - Slide the housing cover up until you hear it snap into place.
- Full access:
  - Remove the two screws on the top of the detector.
  - Slide the housing cover up until you hear it snap into place.
  - Pull the housing cover out slightly at the sides and lift it up.
  - Remove the housing cover.

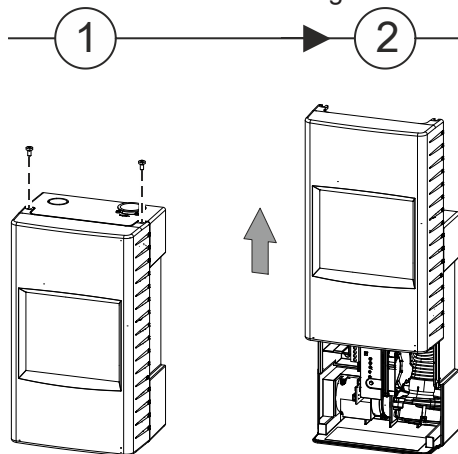

## Service LED indicators and buttons

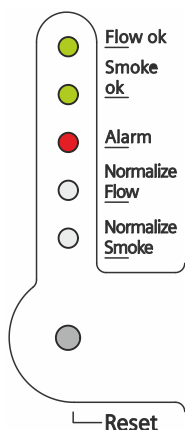

### Flow OK

As soon as the selftest for normal operation has been completed successfully, the 'Flow OK' LED starts to flash.

### Smoke OK

As soon as the selftest for normal operation has been completed successfully, the 'Smoke OK' LED starts to flash.

### Alarm

In the event of a smoke alarm, the 'Alarm' LED starts to flash.

### Normalization of the airflow

To determine the nominal airflow of the detector, perform this function during commissioning. The nominal value established during normalization of the airflow forms the setpoint value for monitoring the airflow during normal operation.

To perform this function, use a thin object (such as a paper clip or a watchmaker's screwdriver) to press the button in the opening.

Once you have finished with this function, press the button in the opening again.

The smoke detector uses standard values for monitoring during normalization.

### Normalization of the smoke density

To determine the nominal air quality in relation to the smoke density, perform this function during commissioning. The nominal value established during normalization forms the setpoint value for monitoring the smoke density during normal operation.

To perform this function, use a thin object (such as a paper clip or a watchmaker's screwdriver) to press the button in the opening.

Once you have finished with this function, press the button in the opening again.

The smoke detector uses standard values for monitoring during normalization.



---

The detector provides information about the current normalization process via FDnet/C-NET (no distinction is made between smoke and airflow).

---

### Reset button

Use the reset button to reset all of the detector's status indicators. These indicators can refer to fire alarms or airflow events. Resetting the fire alarm also resets the associated relay.



---

If the detector is operated on the FDnet/C-NET, the alarms and the associated relays are not reset.

---

### USB connection

You can use a mini USB cable to connect the detector to a Windows PC. To set up the detector, use the configuration tool 'FXS2051 ASD Configuration Tool'.

### Test function LED

Hold the 'Buzzer silence' button down for 5 seconds. The LEDs on the display are tested with 3 different brightness settings.

If the aspirating smoke detector is to be operated on the FDnet/C-NET, the communication interface FDCC221S (S24218-A201-A2) must be ordered separately.

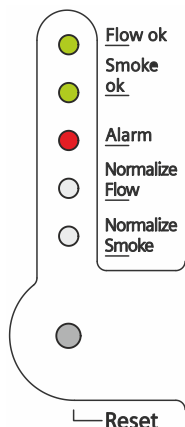

### Accessories

#### Communication interface FDCC221S



- For connecting the aspirating smoke detector to FDnet/C-NET
- Integrated 'line separator' function
- Additional MC link interface (port for 3.5 mm jack)
- Tool-free mounting on a designated PCB slot
- Supplied with:
  - 2x spacers with thread
  - 4-pin plug-in terminal
  - ID adhesive label

#### Power supply kit FP120-Z1



- Standalone power supply (70 W)
- Supply to external devices and components as per EN 54-4 and VdS
- With operating and fault indicator, shown via a green and a yellow LED
- With potential-free relay contacts for fault messages
- Additional installation of an I/O module possible
- Uninterruptible power supply with battery charging
- Batteries: max. 17 Ah
- Dimensions: (W x H x D) 430 x 399 x 124 mm

#### Battery FA2003-A1 (12 V, 7 Ah, VdS)

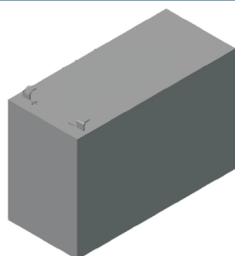

- For supplying fire control panels and aspirating smoke detectors with power
- Compatible with:
  - Fire control panels for the 'Sinteso' and 'Cerberus PRO' product lines
  - External power units for the aspirating smoke detectors FDA241 and FDA221

### Battery FA2004-A1 (12 V, 12 Ah, VdS)

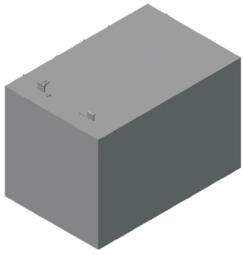

- For supplying fire control panels and aspirating smoke detectors with power
- Compatible with:
  - Fire control panels for the 'Sinteso' and 'Cerberus PRO' product lines
  - External power units for the aspirating smoke detectors FDA241 and FDA221

### Battery FA2005-A1 (12 V, 17 Ah, VdS)

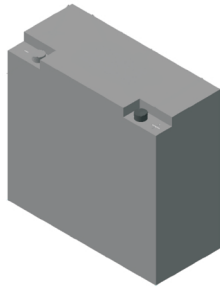

- For supplying fire control panels and aspirating smoke detectors with power
- Compatible with:
  - Fire control panels for the 'Sinteso' and 'Cerberus PRO' product lines
  - External power units for the aspirating smoke detectors FDA241 and FDA221

### FDAZ291 aspirator (FDA241/FDA221)

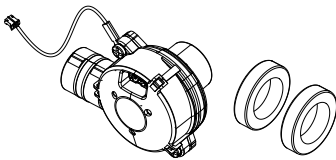

- Spare part for the aspirating smoke detectors FDA241 and FDA221
- You will find more information in document A6V10916366

### FDAZ292 ASD filter box

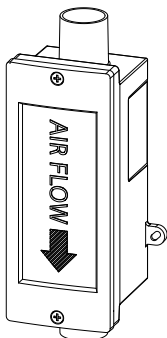

- Filter box for installation in the pipe system for aspirating smoke detectors
- Filters dust and other dirt out of the air aspirated by the aspirating smoke detector
- Minimizes internal contamination of the aspirating smoke detector
- Contains filter set FDAZ292-AA with three filters, coarse/medium/fine
- Compatible with the aspirating smoke detectors FDA241 and FDA221
- You will find more information in document A6V10877841

### FDAZ292-AA ASD filter set

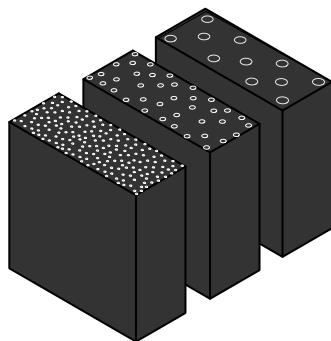

- Spare part for the ASD filter box FDAZ292
- Filter set contains one coarse filter, one medium filter, and one fine filter

## Type Overview

Type	Designation	Order number	Weight [kg]
FDA241	Aspirating smoke detector (8H)	S54333-F17-A1	1.495
FDA221	Aspirating smoke detector (5S)	S54333-F15-A1	1.495
<b>Accessories</b>			
FDCC221S	Communications interface	S24218-A201-A2	0.019
FP120-Z1	Power supply kit A (70 W)	S54400-S122-A1	3.920
FA2003-A1	Battery (12 V, 7 Ah, VdS)	A5Q00019353	2.450
FA2004-A1	Battery (12 V, 12 Ah, VdS)	A5Q00019354	3.930
FA2005-A1	Battery (12 V, 17 Ah, VdS)	A5Q00019677	5.640
FDAZ292	ASD filter box	S54333-C92-A1	0.220
<b>Spare parts</b>			
FDAZ292-AA	ASD filter set	S54333-S91-A1	0.009
FDAZ291	Aspirator (FDA241/FDA221)	S54333-G1-A1	0.106

## Product documentation

Document ID	Title
A6V10334410	Technical manual Aspirating smoke detector FDA241, FDA221
A6V10393194	Technical manual Power supply kit A 70 W FP120-Z1
A6V10345654	Installation, Mounting Aspirating smoke detector FDA241, FDA221
A6V10340094	User Manual 'ASD Asyst Tool FXS2055'
A6V10728226	User Manual 'ASD Asyst Tool V2 FXS2056'
A6V10334435	Planning, Installation ASD Pipe system
A6V10332759	Installation, Operation Manual, Configuration 'ASD Configuration Tool FXS2051'
A6V10877841	Installation ASD Filterbox FDAZ292
A6V10916591	Installation Aspirator (FDA241/FDA221) FDAZ291

Related documents such as environmental declarations, CE declarations, etc., can be downloaded at the following Internet address:

<http://siemens.com/bt/download>

## Notes

### Disposal



The device is considered an electronic device for disposal in accordance with the European Guidelines and may not be disposed of as domestic garbage.

- Dispose of the device through channels provided for this purpose.
- Comply with all local and currently applicable laws and regulations.



**Technical data**

	FDA241	FDA221
Operating voltage	DC 19.5...30 V	
Operating current at DC 24 V	150 mA (nominal), 250 mA (during alarm)	
Dimensions (W x H x D)	162 x 285 x 120 mm	
Protection category	IP30	
Installation position	Vertically upward, vertically downward	
Sound power level LWA [dBA]: <sup>1)</sup>	-	
At suction speed		
- High	37	33
- Medium	33	30
- Low	30	26
Operating temperature	-20...+60 °C	
Air humidity	5...95 % (no moisture condensation)	
Dust indicator	Yes	-
Maximum pipe length		
- Single line	60 m	30 m
- Branched lines	2x 60 m	2x 25 m
Options for aspirating holes	Prefabricated option or the maximum pipe length must correspond to the calculation made using the software 'FXS2056 ASD Asyst Tool V2'	
Air intake/exhaust pipe	Metric: 25 mm outer diameter (OD)	
Monitoring area (dependent on local provisions and standards)	Up to 800 m <sup>2</sup>	Up to 500 m <sup>2</sup>
System compatibility	Compatible with all Siemens FC20/FC720 (FS20/FS720 systems)	
Relay alarm outputs	4	3
Can be selected with/without self-retention		
Nominal current 2.0 A at DC 30 V. Contact: NO/NC		
Fault relay	1	1
Cable inlet	10 cm x 2.5 cm on the rear or from above	
Terminal configuration	Screw terminals	
Conductor cross section	0.2...2.5 mm <sup>2</sup> (AWG 12– 30)	
Other interfaces	Power supply, 4...20 mA	
Alarm threshold for parameter sets:		
Fire 1	10 sets 0.05...2.0 %/m obs	5 sets 0.20...2.0 %/m obs
Fire 2	10 sets 2.0...20 %/m obs	5 sets 6.0...20 %/m obs
Alarm delay, can be set individually	0...300 seconds: default value 0 seconds smoke density and 15 seconds flow	
Indication	<ul style="list-style-type: none"> <li>• 4x alarm status indicators (FDA241)</li> <li>• 3x alarm status indicators (FDA221)</li> <li>• Faults</li> <li>• Blowing out (FDA241)</li> <li>• Dust (FDA241)</li> <li>• Smoke density and flow indicator</li> </ul>	

	FDA241	FDA221
Service area	<ul style="list-style-type: none"> <li>• 'Status OK' LED</li> <li>• USB</li> <li>• Settings for reset functions</li> <li>• Settings for smoke density and airflow</li> </ul>	
Event log	Non-volatile event memory with time and date stamp for: smoke density, airflow, detector status, and faults	
Event memory entries	20000	8000
Modification memory entries	20000	8000
Normalization of smoke value and airflow	<ul style="list-style-type: none"> <li>• Setting of threshold values for smoke alarms and faults</li> <li>• User setting for normalization of smoke density and airflow</li> <li>• Preset values are retained during the normalization period</li> </ul>	
Warranty period	2 years	
Approvals	<b>FDA241</b>	<b>FDA221</b>
<ul style="list-style-type: none"> <li>• VdS</li> </ul>	G213050	G213050

<sup>1</sup> A-weighted sound power level in [dB] as per DIN EN ISO 3744-2009, measured with a pipe piece at the air inlet and at the air outlet

Dimensional drawings

FDA241, FDA221

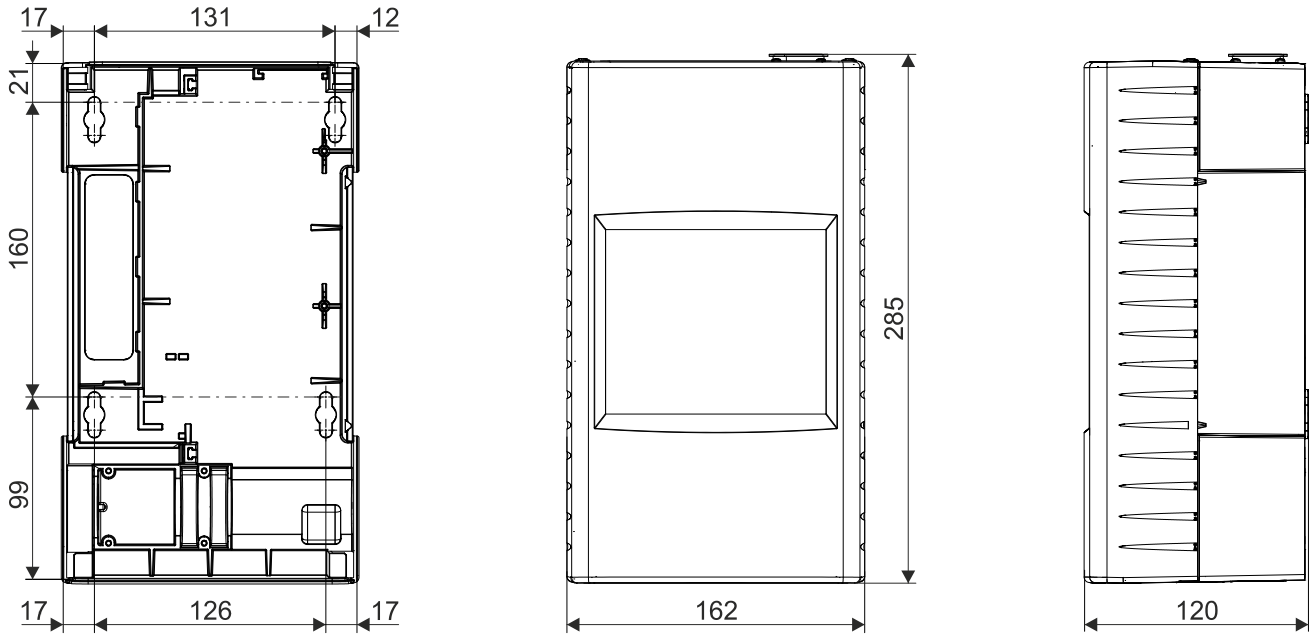

FDAZ292

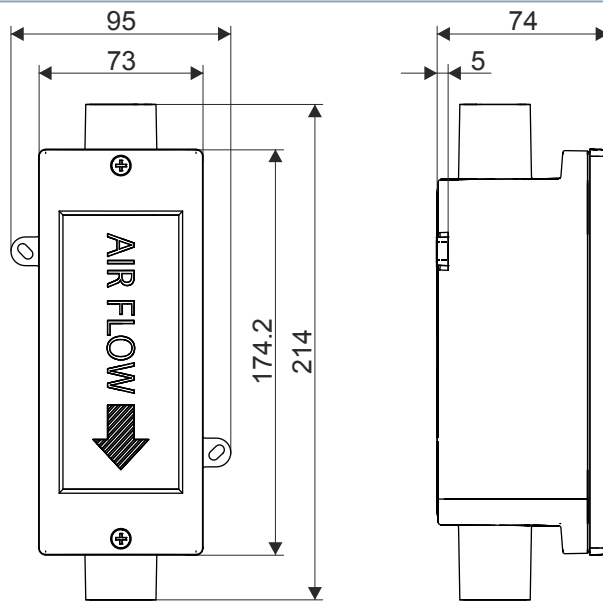

Issued by  
Siemens Switzerland Ltd  
Smart Infrastructure  
Global Headquarters  
Theilerstrasse 1a  
CH-6300 Zug  
+41 58 724 2424  
[www.siemens.com/buildingtechnologies](http://www.siemens.com/buildingtechnologies)

© Siemens Switzerland Ltd, 2013  
Technical specifications and availability subject to change without notice.

---

Document ID    A6V10331032\_k\_en\_--  
Edition        2021-06-28